

EST.

1992



# F I R E P L A C E S



PANTHERM



PANAQUA



PANTECH B



PANTECH JOY



PANTECH EVO PREMIUM

DINAMIKA  
DYNAMICS

TAPASZTALAT  
EXPERIENCE

MEGBÍZHATÓSÁG  
RELIABILITY



if. Haigli Ferenc  
Termelési Igazgató  
Production Manager

A black ink signature of if. Haigli Ferenc.

Haigli Ferenc  
Ügyvezető  
Manager

A black ink signature of Haigli Ferenc.

Haigli Árpád  
Értékesítési Vezető  
Sales Manager

A black ink signature of Haigli Árpád.



## TISZTA ENERGIA / PURE ENERGY

A fa teljes élete alatt annyi szén-dioxidot köt meg, mint amennyit az elégetés során kibocsát. Ezért a fatüzelés megújuló és környezetbarát.

Through the lifetime of timber binds as much Carbon dioxide as generated through the incineration.

When the tree falls and become rotten as much Carbon dioxide generates as through burning.

We can conclude that when firing in fireplace is a renewable energy while its environment friendly and clear.

# JELMAGYARÁZAT

## Symbol explanation



Teljesítmény  
Output



Szélesség  
Width



Súly  
Weight



Úrtartalom  
Tonnage



Hatásfok  
Efficiency



Hatásfok hődobbal  
Efficiency with heat reclaimers



Fahasáb maximális hosszúság  
Wooden blocks max length



Zárt égéstér  
Sealed Chamber



A víz és levegőoldali teljesítmény  
Water and air side performance



Külső levegő bevezetés  
Exterior air supply



CO kibocsátás  
CO emissions



Szükséges kéményhuzat-teljesítmény  
Required chimney draft output



Szállópor koncentrátum  
Fly powder Concentrate



NERO sík üveg (fekete szegélyes üveg)  
NERO flat glass (black border glass)



Visszahűtő rendszer  
Water cooling system



Lábazat  
Footing



Elérhető feltolható ajtóval  
OptionLD modul (lifted door)



Magasítóláb  
Elevating footing

## PANTHERM

Tűztér család / Firebox Family

PanTherm 62	9
PanTherm 68	10
PanTherm 68 LD	11
PanTherm 69 CG L	12
PanTherm 69 CG R	13
PanTherm 75 CG L	14
PanTherm 75 CG R	15

## PANAQUA

Vízköpenyes Tűztér család /  
Water-Jacketed Firebox Family

PanAqua mini	18
PanAqua 15 KW	19
PanAqua 20 KW	20
PanAqua 20 KW TUNNEL	21
PanAqua 25 KW	22
PanAqua 30 KW	23
PanAqua 30 KW TUNNEL	24
PanAqua 75 CG L	26
PanAqua 75 CG R	27
PanAqua 110	28
PanAqua 110 TUNNEL	29
PanAqua 68 EVO	30
PanAqua 80 EVO	31
PanAqua 110 EVO	32
PanAqua 80 EVO LD	33
PanAqua 100 EVO LD	34
PanAqua 130 EVO LD	35
PanAqua EVO d160	36

Kályha / Stove

## PANTECH B

Tűztér család / Firebox Family

PanTech 45 B CG	40
PanTech 50 B T	41
PanTech 60 B	42
PanTech 60 BU	43
PanTech 60 B CG L	44
PanTech 60 B CG R	45
PanTech 68 B	46
PanTech 70 BU	47
PanTech 69 B CG L	48

7-15

16-36

38-52

PanTech 69 B CG R	49
PanTech 75 B CG L	50
PanTech 75 B CG R	51
PanTech 80 B	52

## PANTECH MOBIL

Tűztér család / Firebox Family

PanTech 60 B Mobil	54
black / white 1+2	
PanTech 60 B Mobil	55
black / white 2+2	
PanTech 60 B CG R Mobil	56
black / white 1+2	
PanTech 60 B CG R Mobil	57
black / white 2+2	
PanTech 60 B CG L Mobil	58
black / white 1+2	
PanTech 60 B CG L Mobil	59
black / white 2+2	
PanTech 60 B U Mobil	60
black / white 1+2	
PanTech 60 B U Mobil	61
black / white 2+2	
PanTech 80 JOY U LD MOBIL	62
black / white 1+2	
PanTech 80 JOY V LD MOBIL	63
black / white 1+2	

## PANTECH JOY

Tűztér család / Firebox Family

PanTech 80 JOY CG LD L	68
PanTech 80 JOY CG LD R	69
PanTech 80 JOY U LD	70
PanTech 80 JOY V LD	71
PanTech 100 JOY CG L	72
PanTech 100 JOY CG R	73
PanTech 100 JOY LD	74

## PANTECH EVO PREMIUM

Tűztér család / Firebox Family

PanTech 68 EVO	78
PanTech 68 EVO TUNNEL	79
PanTech 80 EVO	80

53-61

66-75

76-99

PanTech 80 EVO TUNNEL	81
PanTech 80 EVO LD	82
PanTech 80 EVO LD TUNNEL	83
PanTech 90 EVO CG LD L	84
PanTech 90 EVO CG LD R	85
PanTech 100 EVO LD	86
PanTech 100 EVO LD TUNNEL	87
PanTech 100 EVO U LD	88
PanTech 100 EVO V LD	89
PanTech 110 EVO	90
PanTech 110 EVO TUNNEL	91
PanTech 130 EVO LD	92
PanTech 130 EVO LD TUNNEL	93
PanTech 160 EVO LD	94
PanTech 200 EVO LD	95

## PANTECH

Tűztér család / Firebox Family

PanTech CLASSIC 95	96
PanTech CLASSIC 110	97
PanBox 68	98
PanBox 110	99

## HŐDOBOK

Heat reclaimers

Hődob 150	101
Hődob 200	102
Vizes hődob Mini és Maxi •	103
Water Heat reclaimer Mini and Maxi	

## KIEGÉSZÍTŐK

Accessories

104-108

## TECHNICAL TŰZTEREK

A tűz varázsa otthonában

Feladatunk, hogy minél magasabb minőségű és hosszú élettartamú termékekkel tudjuk kiszolgálni vevőinket, ezért rendelkeznek tűztereink egyedülállóan nagy falvastagsággal, igen magas hőleadó felülettel, és az előírtnál jobb anyagminőséggel. Adott kategóriában a legnagyobb súllyal rendelkeznek tűztereink, melyek a legszigorúbb és legújabb TÜV európai normás vizsgálatokon az elérhető legjobb minősítést kapták. Minden Technical tűztér magyar termék. A kandallógyártásban szerzett tapasztalatunk 1992 óta az 5 és 7 év garanciás tűztereink kiváló minőséget és megbízhatóságot garantálnak. Központi fűtésre köthető vizes és légfűtő tűztereink a megfelelő kiegészítők alkalmazásával 80% feletti hatásfok leadására képesek, ami az elérhető maximum. Nem takarékoskodtunk a felhasznált anyagok minőségével, vastagságával valamint az alapos és hosszú mérnöki fejlesztőmunkával sem. További információval szívesen állunk rendelkezésükre bemutatótermeinkben illetve telefonon. Termékválasztékunk folyamatosan bővül.

## TECHNICAL FIREBOXES

Magic of fire at home

Our objective is to offer high quality and long lasting products to our customers. For this reason our products have uniquely thick walls, big heat dissipation surface and better quality of materials than prescribed. In its category these fireboxes are the number ones and received the highest qualification in a stricter and latest examinations. All Technical fireboxes are Hungarian products. We guarantee the excellent quality and reliability by Since 1992 experience at firebox manufacturing, 5 to 7 year guarantee of some of our fireboxes. Waterjacket and air heater fireboxes, with a help of the appropriate accessories, are able to function with 80 % of efficiency, which is the maximum that can be attained. We don't economize on high quality materials, their thickness or thorough and long engineering. We are at your disposal for further information at our showrooms or by phone. Our product scale is broadening.



# PANTHERM

Tűztér család / Firebox family



## Teljesítmény és hatásfok:

A kiváló hatásfok, teljesítmény és környezettudatos kivitel érdekében, nagy hőleadó felületek, Eco és EcoPlus égésvezérlések. A huzatszabályzó pillangószelep alapfelszereltség minden típus esetében, kivéve egyes modelleknél.

## Élettartam:

Hosszú élettartalmú, robusztus, vastagfalú kivitelek. Tapasztalata és alapos mérnöki fejlesztő munka eredménye 1992 óta.

## Design:

Maximális üvegfelületek, hagyományos és NERO üvegezéssel, akár minden oldalról üveges, trapéz és íves ajtók variálhatóságával.

## ECO rendszer / system:

Harmadlagos levegőellátást biztosít, mely lehetővé teszi a füstgázokban visszamaradó, éghető gázok elégetését, növeli a hatásfokot és a teljesítményt, továbbá az üzemeltetés is környezetbarát.

It assures extra air supply, that allows the burning of flue gases remaining from the exhaust fumes, raises the efficiency, the performance and the operation is environmentally friendly.

## EcoPlus rendszer / system:

Tartalmazza az ECO utánégető rendszert, azzal a plusz szolgáltatással, amely lehetővé teszi a tűztér teljes, fokozatmentes égésszabályzását külső levegő ellátással.

It contains the Eco system with an extra service that assures complete and ungraded damper in the fireboxes with external air supply.

## Efficiency and performance:

To obtain excellent efficiency, performance and environmentally friendly implementation, fireboxes contain big heat dissipation surfaces, Eco and EcoPlus system. The baffle valve is the part of all types of fireboxes.

## Lifetime:

The long lifetime, robust and thick wall constructions are the results of the Since 1992 experience and thorough engineering.

## Desing:

Big glass surfaces, with traditional or NERO glazing. All sides can be glass, with trapezoid or cambered glass.

# PANTHERM

Szerkezet / Structure 62, 68



1 Füsttömeg szabályozás. Fontos a füsttömeg kiáramlásának torlasztása az égésidő és a hatásfok növelésének érdekében. Regulation of the smoke crowd. To reach the improving burning time and the efficiency with the help of the blocking of the exhaust of the smoke is important

2 Lángterelő  
Flame deflector

3 Secunder levegő, légfüggöny  
Secondary air, air curtain

4 Hőleadó borda  
Heat rejection panel

5 Rostély  
Grate

6 Hamufiók  
Ash tray

7 Fafogó  
Log holding



**TECHNICAL**

# PANTHERM

62



**GARANCIA  
GUARANTEE**

**TÜV  
CERTIFICATIONS**



13 kW



62 cm



125 kg



76 %



14-16 PA



81 %



35 cm



Option



Lábazat  
/ Legs  
Option



**NERO  
Design**



**NERO  
Option**

- Minden típushoz rendelhető
- All types available



Left



Right



Left and Right



Four Glasses



TUNNEL



TUNNEL left



TUNNEL right



ECO



ECO +



Convectional



**150**  
flue base  
construction  
fűstcsonk  
átmérő

**200**  
flue can be  
ordered  
választható  
fűstcsonk  
átmérő

# PANTHERM

68



**GARANCIA  
GUARANTEE**

**TÜV**  
CERTIFICATIONS



15 kW



68 cm



135 kg



76 %



14-16 PA



82 %



40 cm



Option



Lábazat  
/ Legs  
Option



**NERO  
Design**



NERO  
Option

- Minden típushoz rendelhető
- All types available



Left



Right



Left and Right



Four Glasses



TUNNEL



TUNNEL left



TUNNEL right



ECO



ECO +



Convictional

**200**  
flue base  
construction  
fűtőcsanak  
átmérő

**150**  
flue can be  
ordered  
választható  
fűtőcsanak  
átmérő

# PANTHERM

68 LD



15 kW



68 cm



215 kg



76 %



14-16 PA



82 %



40 cm



Standard



Lábazat  
/ Legs  
Option



NERO  
Standard



**200**

flue base  
construction  
fűtőcsőnk  
átmérő

 TECHNICAL

# PANTHERM

69 CG L



GARANCIA  
GUARANTEE

**TÜV**  
CERTIFICATIONS



ECO



ECO +



Convectional



13 kW



69 cm



121 kg



76 %



81 %



40 cm



Option



Lábazat / Legs  
Option



14-16 PA

 **200**  
flue base  
construction  
füstcsonk  
átmérő

 **150**  
flue can be  
ordered  
választható  
füstcsonk  
átmérő

# PANTHERM

69 CG R



ECO



ECO +



Convectional



13 kW



69 cm



121 kg



76 %



81 %



40 cm



Option



Lábazat  
/ Legs  
Option



14-16 PA

 **200**  
flue base  
construction  
fűtcsonk  
átmérő

 **150**  
flue can be  
ordered  
választható  
fűtcsonk  
átmérő

# PANTHERM

75 CG L



ECO

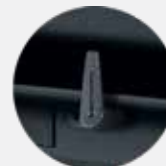

ECO +



Convectional

A képen látható tüztér NERO üveg opciót tartalmaz. / NERO glazing in the picture is optional.



15 kW



75 cm



129 kg



76 %



82 %



40 cm



Option



Lábazat  
/ Legs  
Option



14-16 PA



NERO  
optional

**200**  
flue base  
construction  
füstcsanak  
átmérő

# PANTHERM

75 CG R



ECO



ECO +



Convectional

A képen látható tűztér NERO üveg opciót tartalmaz. / NERO glazing in the picture is optional.



15 kW



75 cm



129 kg



76 %



82 %



40 cm



Option



Lábazat  
/ Legs  
Option



14-16 PA



NERO  
optional

**200**  
flue base  
construction  
fűstcsanak  
átmérő

# PANAQUA

Vízköpenyes tűztér család  
Water-Jacketed firebox family



## Teljesítmény és hatásfok:

Az elérhető legmagasabb hatásfok, teljesítmény és környezettudatos kivitel. Nagy hőleadó felületek és 80% feletti hatásfok. Panaqua EVO: levegő előmelegítő rendszerrel.

## Élettartam:

Hosszú élettartamú, robusztus, vastagfalú kivitelek. 30 év tapasztalata és alapos mérnöki fejlesztő munka eredménye.

## Design:

Maximális üvegfelület, modern esztétikus kialakítás, tűztérhez simuló kezelőszervek.

## Efficiency and performance:

To obtain excellent efficiency, performance and environmentally friendly implementation, fireboxes contain big heat dissipation surfaces, Eco and EcoPlus system. The baffle valve is the part of all types of fireboxes. Panaqua EVO: with preheater system.

## Lifetime:

The long lifetime, robust and thick wall constructions are the results of the 30-year experience and thorough engineering.

## Desing:

Big glass surfaces, modern, stunning design, practical output.



# PANAQUA EVO

Szerkezet / Structure

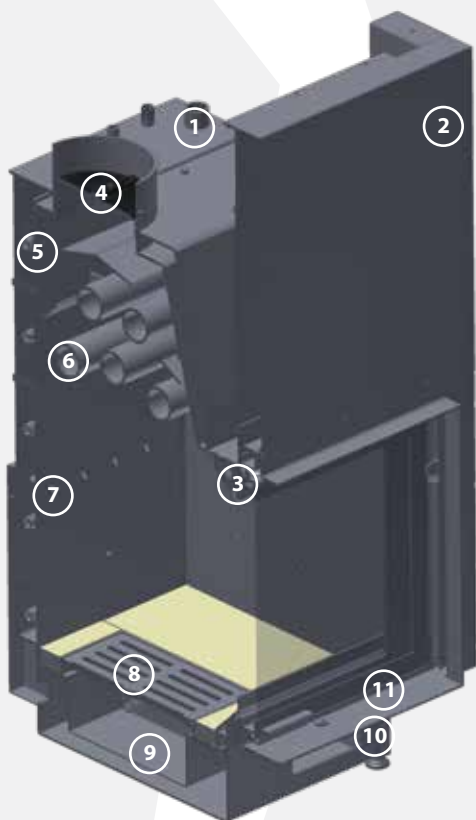

1 Bekötő csatlakozások  
Accessing connectors

2 Ajtóemelő szerkezet  
Door lifting structure

3 Secunder levegő, légfüggöny  
Secondary air, air curtain

4 Füsttömeg szabályozás. Fontos a füsttömeg kiáramlásának torlasztása az égésidő és a hatásfok növelésének érdekében.  
Regulation of the smoke crowd. To reach the improving burning time and the efficiency with the help of the blocking of the exhaust of the smoke is important

5 Visszahűtő  
Intercooler

6 Vízcövek- vízköpeny  
Water tubes – water jacket

7 Harmadlagos levegő  
Tertiary air

8 Rostély  
Grate

9 Hamuláda  
Ash box

10 Szintezőláb  
Leveling feet

11 Levegő szabályzókar  
Air controlling lever

 TECHNICAL

PANAQUA

Mini



GARANCIA  
GUARANTEE

TÜV  
CERTIFICATIONS

Options  
Opciók

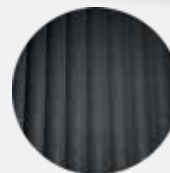

Ajánlott Vermikulit bélésel  
Option Vermiculite Linings



7-12 KW



33 l



68 cm



110 kg



>76 %



40 cm



Standard



Visszahűtő  
rendszer  
/ Safety  
system



Lábazat  
/ Legs  
Option



14-16 PA



9 kW /  
3 kW

 **150**  
flue base  
construction  
fűtőcsanak  
átmérő

 TECHNICAL

PANAQUA

15 kW



GARANCIA  
GUARANTEE

TÜV  
CERTIFICATIONS

Options  
Opciók



Ajánlott Vermikulit béléssel  
Option Vermiculite Linings



9-15 KW



39 l



62 cm



174 kg



80 %



35 cm



Standard



Visszahűtő  
rendszer  
/ Safety  
system



Lábazat  
/ Legs  
Option



14-16 PA



12 kW /  
3 kW

Ø **150**  
flue base  
construction  
fűtőcső  
átmérő

 TECHNICAL

PANAQUA

20 kW



GARANCIA  
GUARANTEE

TÜV  
CERTIFICATIONS

Options  
Opciók

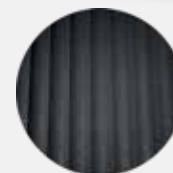

Ajánlott Vermikulit béléssel  
Option Vermiculite Linings



12-20 kW



42 l



68 cm



189 kg



80 %



40 cm



Standard



Visszahűtő  
rendszer  
/ Safety  
system



Lábazat  
/ Legs  
Option



14-16 PA



16 kW /  
4 kW

 **200**  
flue base  
construction  
fűtőcsanak  
átmérő

### Options Opciók



Ajánlott Vermikulit béléssel  
Option Vermiculite Linings



12-20 kW



36 l



68 cm



210 kg



80 %



40 cm



Standard



Visszahűtő  
rendszer  
/ Safety  
system



Lábazat  
/ Legs  
Option



14-16 PA



16 kW /  
4 kW

 **200**  
flue base  
construction  
fűtőcsanak  
átmérő

 TECHNICAL

PANAQUA

25 kW



GARANCIA  
GUARANTEE

TÜV  
CERTIFICATIONS

Options  
Opciók

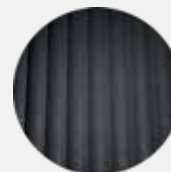

Ajánlott Vermikulit béléssel  
Option Vermiculite Linings



15-25 kW



51 l



71 cm



215 kg



80 %



45 cm



Standard



Visszahűtő  
rendszer  
/ Safety  
system



Lábazat  
/ Legs  
Option



14-16 PA



20 kW /  
5 kW

 **200**  
flue base  
construction  
fűtőcső  
átmérő



Ajánlott Vermikulit béléssel  
Option Vermiculite Linings



18-30 kW



55 l



80 cm



238 kg



80 %



55 cm



Standard



Visszahűtő  
rendszer  
/ Safety  
system



Lábazat  
/ Legs  
Option



14-16 PA



24 kW /  
6 kW

**200**  
flue base  
construction  
fűtőcső  
átmérő

 TECHNICAL

PANAQUA

30 kW TUNNEL



GARANCIA  
GUARANTEE

TÜV  
CERTIFICATIONS

Options

Opciók

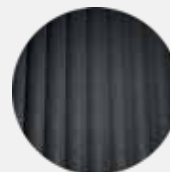
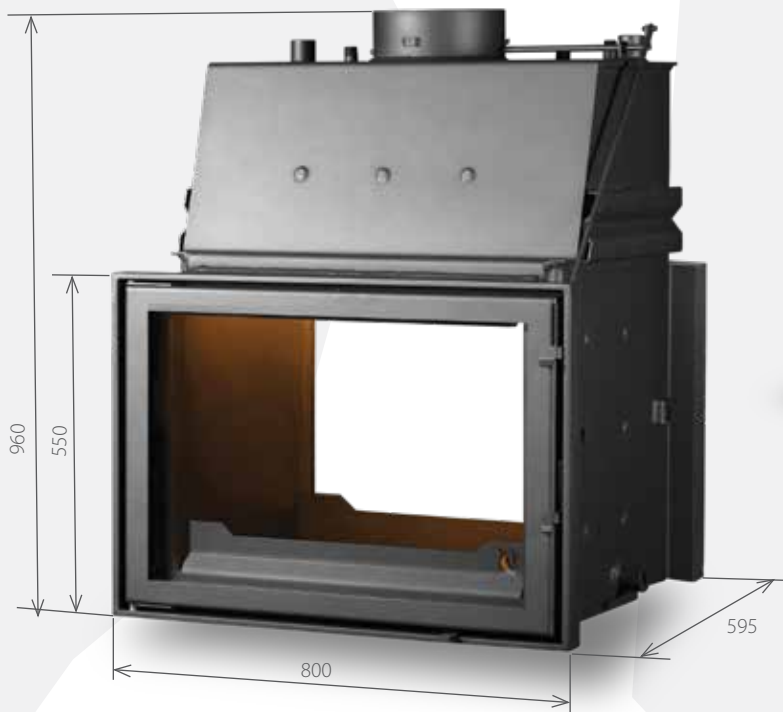

Ajánlott Vermikulit béléssel  
Option Vermiculite Linings



18-30 kW



45 l



80 cm



253 kg



80 %



55 cm



Standard



Visszahűtő  
rendszer  
/ Safety  
system



Lábazat  
/ Legs  
Option



14-16 PA



21 kW /  
9 kW

 **200**  
flue base  
construction  
füstcsanak  
átmérő





 TECHNICAL

PANAQUA

75 CG L



GARANCIA  
GUARANTEE

TÜV  
CERTIFICATIONS

Options  
Opciók

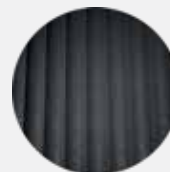
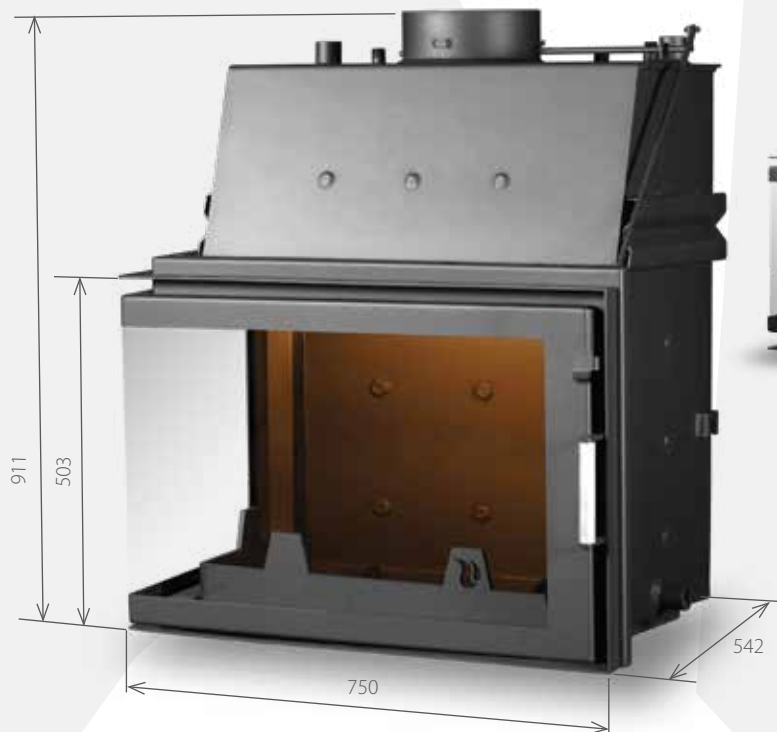

Ajánlott Vermikulit béléssel  
Option Vermiculite Linings

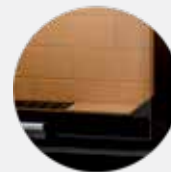

NERO  
Design



14-24 kW



43 l



75 cm



209 kg



80 %



45 cm



Standard



Visszahűtő  
rendszer  
/ Safety  
system



Lábazat  
/ Legs  
Option



14-16 PA



NERO  
Option



18 kW /  
6 kW

 **200**  
flue base  
construction  
fűtőcsőnk  
átmérő

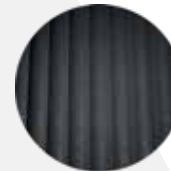
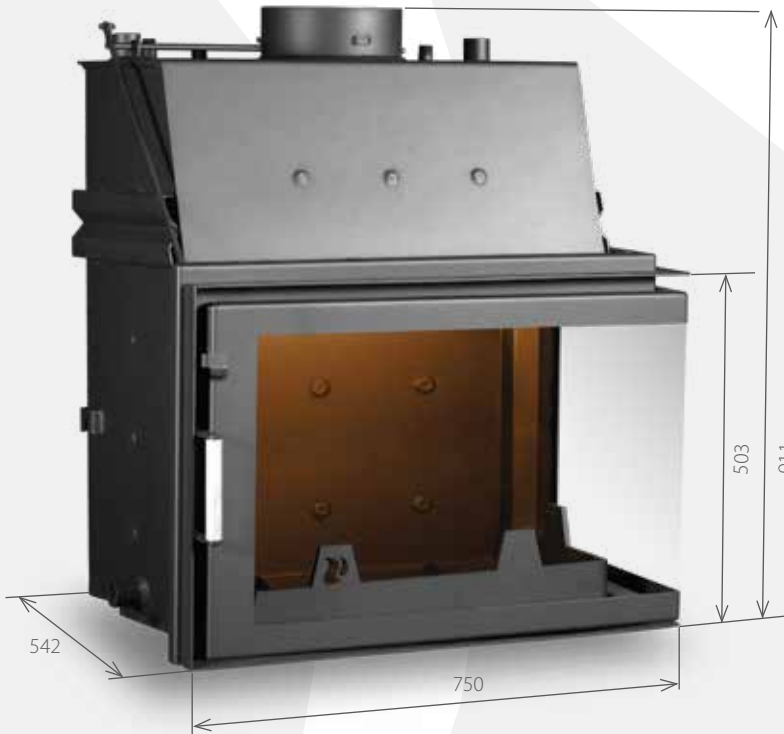

Ajánlott Vermikulit bélésel  
Option Vermiculite Linings



NERO  
Design



14-24 kW



43 l



75 cm



209 kg



80 %



45 cm



Standard



Visszahűtő  
rendszer  
/ Safety  
system



Lábazat  
/ Legs  
Option



14-16 PA



NERO  
Option



18 kW /  
6 kW

Ø **200**

 TECHNICAL

PANAQUA

110



GARANCIA  
GUARANTEE

TÜV  
CERTIFICATIONS

Options  
Opciók

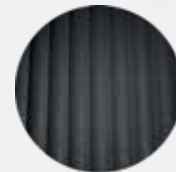

Ajánlott Vermikulit béléssel  
Option Vermiculite Linings



18-30 kW  
24-40 kW



72/75 l



110 cm



300/310 kg



80 %



70 cm



Standard  
Visszahűtő  
rendszer  
/ Safety  
system



Lábazat  
/ Legs  
Option



14-16 PA



21 kW /  
9 kW

30kW ~~Ø~~ **200**  
flue base  
construction  
fűstcsonk  
átmérő

40kW ~~Ø~~ **250**  
flue can be  
ordered  
választható  
fűstcsonk  
átmérő

# PANAQUA

110 TUNNEL



GARANCIA  
GUARANTEE

**TÜV**  
CERTIFICATIONS

Options  
Opciók

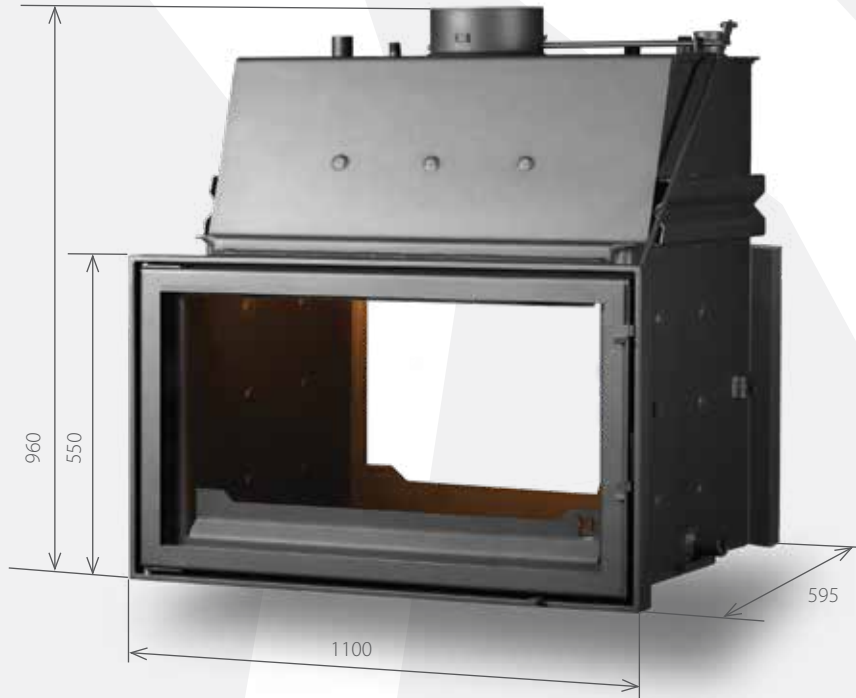

Ajánlott Vermikulit béléssel  
Option Vermiculite Linings



18-30 kW



60 l



110 cm



329 kg



80 %



70 cm



Standard



Visszahűtő  
rendszer  
/ Safety  
system



Lábazat  
/ Legs  
Option



14-16 PA



18 kW /  
12 kW

 **200**  
flue base  
construction  
fűtőcső  
átmérő

**TECHNICAL**

**PANAQUA**

68 EVO



**TÜV** 15aB-VG BImSchV2.  
CERTIFICATIONS



**GARANCIA  
GUARANTEE**

Options  
Opciók

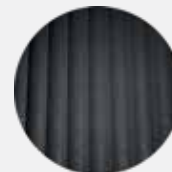

Ajánlott Vermikulit béléssel  
Option Vermiculite Linings



12-20 kW



47 l



68 cm



222 kg



> 80 %



40 cm



Standard



Zárt égéstér  
Sealed Chamber



Visszahűtő  
rendszer  
/ Safety  
system



0,09 %



14-16 PA



25  
mg/Nm<sup>3</sup>



NERO  
Standard



16 kW /  
4 kW



**200**  
flue base  
construction  
fűtőcsanak  
átmérő

**TECHNICAL**

**PANAQUA**

80 EVO



**TÜV** 15aB-VG **BlmSchV2.**  
CERTIFICATIONS



**GARANCIA  
GUARANTEE**

Options  
Opciók



Ajánlott Vermikulit béléssel  
Option Vermiculite Linings



18-30 kW



56 l



80 cm



260 kg



> 80 %



55 cm



Standard



Zárt égéstér  
Sealed Chamber



Visszahűtő  
rendszer  
/ Safety  
system



0,09 %



14-16 PA



25  
mg/Nm<sup>3</sup>



NERO  
Standard



22 kW /  
8 kW



**200**  
flue base  
construction  
fűtőcső  
átmérő

**TECHNICAL**

**PANAQUA**

110 EVO



**TÜV** 15aB-VG BImSchV2.  
CERTIFICATIONS



**GARANCIA  
GUARANTEE**

Options  
Opciók

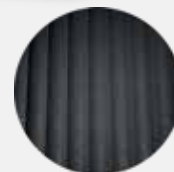

Ajánlott Vermikulit bélésel  
Option Vermiculite Linings



18-30 kW



74 l



110 cm



341 kg



> 80 %



70 cm



Standard



Zárt égéster  
Sealed Chamber



Visszahűtő  
rendszer  
/ Safety  
system



0,09 %



14-16 PA



25  
mg/Nm<sup>3</sup>



NERO  
Standard



24 kW /  
6 kW



**200**  
flue base  
construction  
fűtőcsőnk  
átmérő



**TECHNICAL**

**PANAQUA**

80 EVO LD



**TÜV** 15aB-VG **BlmSchV2.**  
CERTIFICATIONS



**GARANCIA  
GUARANTEE**

Options  
Opciók



Ajánlott Vermikulit béléssel  
Option Vermiculite Linings



12-20 kW



47 l



84 cm



276 kg



> 80 %



40 cm



Standard



Zárt égéstér  
Sealed Chamber



Visszahűtő  
rendszer  
/ Safety  
system



0,09 %



14-16 PA



25  
mg/Nm<sup>3</sup>



NERO  
Standard



16 kW /  
4 kW



**200**  
flue base  
construction  
fűtőcsanak  
átmérő

**TECHNICAL**

**PANAQUA**

100 EVO LD



**TÜV** 15aB-VG BImSchV2.  
CERTIFICATIONS



**GARANCIA  
GUARANTEE**

Options  
Opciók

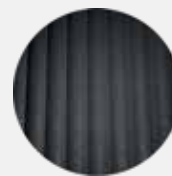

Ajánlott Vermikulit béléssel  
Option Vermiculite Linings



18-30 kW



56 l



96 cm



318 kg



> 80 %



55 cm



Standard



Zárt égéstér  
Sealed Chamber



Visszahűtő  
rendszer  
/ Safety  
system



0,09 %



14-16 PA



25  
mg/Nm<sup>3</sup>



NERO  
Standard



22 kW /  
8 kW



**200**  
flue base  
construction  
fűtőcsőnk  
átmérő

**TECHNICAL**

**PANAQUA**

130 EVO LD



**TÜV** 15aB-VG **BlmSchV2.**  
CERTIFICATIONS



**GARANCIA  
GUARANTEE**

Options  
Opciók



Ajánlott Vermikulit béléssel  
Option Vermiculite Linings



18-30 kW



74 l



126 cm



414 kg



> 80 %



70 cm



Standard



Zárt égéstér  
Sealed Chamber



Visszahűtő  
rendszer  
/ Safety  
system



0,09 %



14-16 PA



25  
mg/Nm<sup>3</sup>



NERO  
Standard



21 kW /  
9 kW



**200**  
flue base  
construction  
fűtőcsanak  
átmérő

# PANAQUA KÁLYHA / STOVE

EVO d160

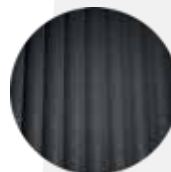

Ajánlott Vermikulit béléssel  
Option Vermiculite Linings



5-9 kW



195 kg



>86 %



35 cm



Standard



NERO  
Standard



Zárt égéstér  
Sealed  
Chamber



Zárt rendszer  
/ Closed  
system



14-16 PA



7 kW /  
2 kW

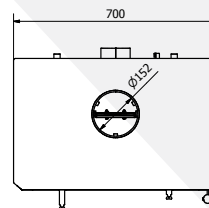
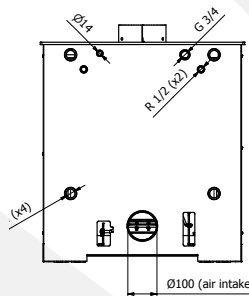
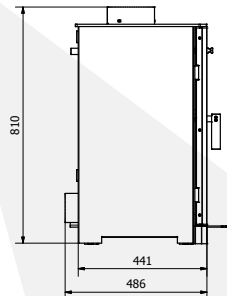
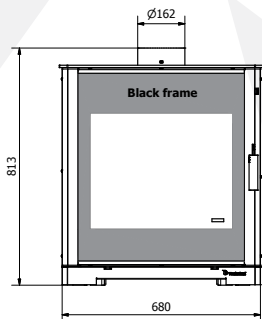

**Ø160**  
flue base  
construction  
fűtcsónk  
átmérő



# PANTECH B

Tűztér család / Firebox family



## Teljesítmény és hatások:

Az öntvény tűztereknél kisebb teljesítmény leadása mellett is kiváló hatásokkal tud működni. Zárt égésterű kivitel. Külső levegő ellátású levegő előmelegítő rendszerrel.

## Élettartam:

4 mm-es falvastagságok, samott-vermikulit bélés, porleválasztó és lángterelő rendszer alkalmazása öntvény füstcsapantyúval. Magas szintű, hosszú fejlesztő mérnöki munka eredménye.

## Design:

Diszkrét kezelőszervek, maximális üvegfelület, NERO üvegezés. Ez a tűztér már a jövő elvárásainak megfelelő technológiai fejlesztéssel készült.

## Efficiency and performance:

Excellent efficiency even with less power output. Closed combustion chamber with external air supply preheating system. All of our Pantech B model designed as slow-burning insert.

## Lifetime:

4 mm thick walls, chamotte-vermiculite inner lining, dust extraction and flame deflection system with cast iron smoke volume regulator.

## Desing:

Big glass surfaces, modern, stunning design, practical output.

# PANTECH B

Szerkezet  
Structure



Füsttömeg szabályozás. Fontos a füsttömeg kiáramlásának torlasztása az égésidő és a hatásfok növelésének érdekében.

1 Regulation of the smoke crowd. To reach the improving burning time and the efficiency with the help of the blocking of the exhaust of the smoke is important

2 Secunder levegő, légfüggöny  
Secondary air, air curtain

3 Hőálló bélés  
Thermostable padding

4 Szintezőláb  
Leveling feet

5 Légfüggöny szabályzókar  
Air curtain control lever

6 Égési levegő szabályzókar  
Combustion air control lever

 TECHNICAL

PANTECH

45 B CG

TÜV 15aB-VG BImSchV2.  
CERTIFICATIONS



GARANCIA  
GUARANTEE



Opció  
magasító láb/  
Option  
elevating legs

Alap kivitel fekete bélés,  
opcionális fehér bélés  
Standard black Linings,  
Option white Linings



4-6 KW



45 cm



83 kg



> 80 %



25 cm



Standard



NERO  
Standard



14-16 PA



Zárt égéstér  
Sealed Chamber



**150**  
flue base  
construction  
fűtőcsanak  
átmérő



# PANTECH

50 BT



GARANCIA  
GUARANTEE



Opció  
magasító láb/  
Option  
elevating legs



Alap kivitel fekete bélés,  
opcionális fehér bélés  
Standard black Linings,  
Option white Linings



8 kW



45 cm



115 kg



> 80 %



max  
30 cm



Standard



NERO  
Standard



14-16 PA



Zárt égéstér  
Sealed Chamber



**200**  
flue base  
construction  
fűstcsonk  
átmérő

 TECHNICAL

PANTECH

60 B



TÜV 15aB-VG BImSchV2.  
CERTIFICATIONS



GARANCIA  
GUARANTEE

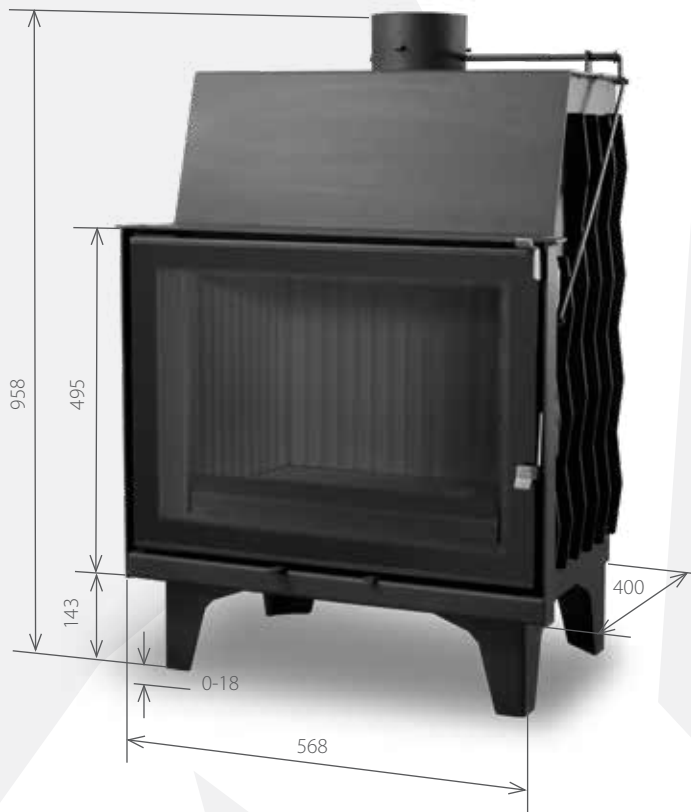

Szintező láb  
Leveling foot



Opció  
magasító láb/  
Option  
elevating legs

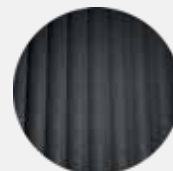

Alap kivétel fekete bélés,  
opcionális fehér bélés  
Standard black Linings,  
Option white Linings



4-6 kW



58 cm



100 kg



> 80 %



33 cm



Standard



NERO  
Standard



14-16 PA



Zárt égéstér  
Sealed Chamber



**150**  
flue base  
construction  
fűtőcsőnk  
átmérő

 TECHNICAL

PANTECH

60 BU



TÜV 15aB-VG BImSchV2.  
CERTIFICATIONS



GARANCIA  
GUARANTEE



NERO  
Standard

Alap kivitel fekete bélés,  
opcionális fehér bélés  
Standard black Linings,  
Option white Linings



4-6 kW



58 cm



94 kg



> 80 %



30 cm



Zárt égéster  
Sealed  
Chamber



Standard



14-16 PA



Opció  
magasító láb/  
Option  
elevating legs



150

flue base  
construction  
fűtőcsanak  
átmérő

 TECHNICAL

PANTECH

60 B CG L



TÜV 15aB-VG BImSchV2.  
CERTIFICATIONS



GARANCIA  
GUARANTEE



Opció  
magasító láb/  
Option  
elevating legs

Alap kivitel fekete bélés,  
opcionális fehér bélés  
Standard black Linings,  
Option white Linings



4-6 kW



58 cm



95 kg



> 80 %



33 cm



Standard



NERO  
Standard



14-16 PA



Zárt égéstér  
Sealed Chamber



150

flue base  
construction  
fűtcsanak  
átmérő

 TECHNICAL

PANTECH

60 B CG R



TÜV 15aB-VG BImSchV2.  
CERTIFICATIONS



GARANCIA  
GUARANTEE



Opció  
magasító láb/  
Option  
elevating legs

Alap kivitel fekete bélés,  
opcionális fehér bélés  
Standard black Linings,  
Option white Linings



4-6 kW



58 cm



95 kg



> 80 %



33 cm



Standard



NERO  
Standard



14-16 PA



Zárt  
égéstér  
Sealed Chamber



**150**  
flue base  
construction  
fűtcsanak  
átmérő

**TECHNICAL**

**PANTECH**

68 B



**TÜV** 15aB-VG BImSchV2.  
CERTIFICATIONS



**GARANCIA  
GUARANTEE**

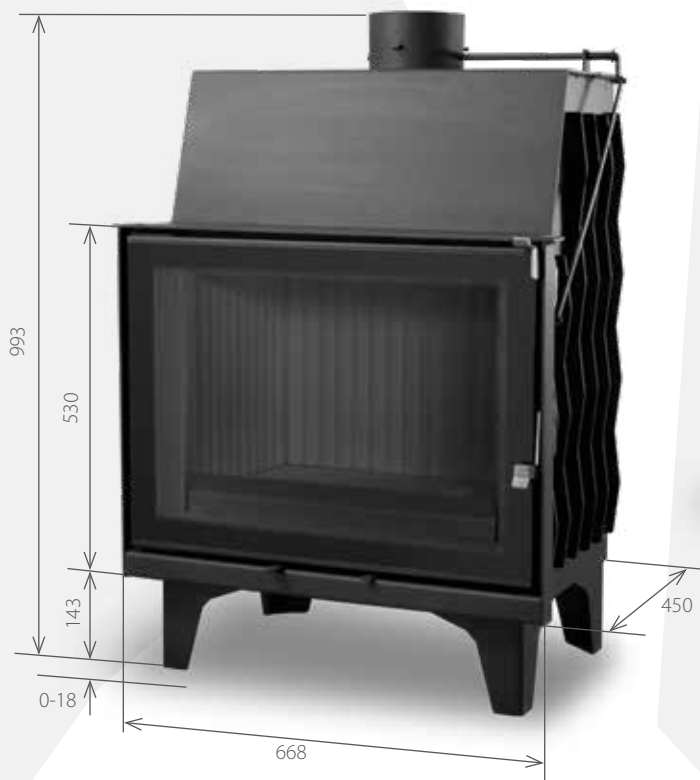

Szintező láb  
Leveling foot

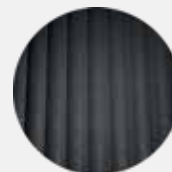

Alap kivétel fekete bélés,  
opcionális fehér bélés  
Standard black Linings,  
Option white Linings

**150**  
flue base  
construction  
fűtőcsanak  
átmérő



5-8 kW



68 cm



123 kg



> 80 %



40 cm Zárt égéster  
Sealed Chamber  
standard



Standard



NERO  
Standard



14-16 PA



Magasító  
láb/  
elevating  
legs

 TECHNICAL

PANTECH

70 BU



TÜV 15aB-VG BImSchV2.  
CERTIFICATIONS



GARANCIA  
GUARANTEE

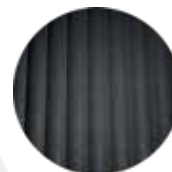

NERO  
Standard

Alap kivitel fekete bélés,  
opcionális fehér bélés  
Standard black Linings,  
Option white Linings



4-7 kW



68 cm



109 kg



> 80 %



35 cm



Zárt égéstér  
Sealed  
Chamber



Standard



14-16 PA



Opció  
magasító láb/  
Option  
elevating legs



200

flue base  
construction  
füstcsonk  
átmérő

 TECHNICAL

PANTECH

69 B CG L



TÜV 15aB-VG BImSchV2.  
CERTIFICATIONS



GARANCIA  
GUARANTEE



Opció  
magasító láb/  
Option  
elevating legs

Alap kivitel fekete bélés,  
opcionális fehér bélés  
Standard black Linings,  
Option white Linings



5-8 kW



69 cm



95 kg



> 80 %



33 cm



Standard



NERO  
Standard



14-16 PA



Zárt  
égéstér  
Sealed Chamber



**150**  
flue base  
construction  
fűtcsanak  
átmérő



 TECHNICAL

PANTECH

69 B CG R



**TÜV** 15aB-VG BImSchV2.  
CERTIFICATIONS



GARANCIA  
GUARANTEE



Opció  
magasító láb/  
Option  
elevating legs



Alap kivitel fekete bélés,  
opcionális fehér bélés  
Standard black Linings,  
Option white Linings



5-8 kW



69 cm



95 kg



> 80 %



33 cm



Standard



NERO  
Standard



14-16 PA



Zárt égéstér  
Sealed Chamber



**150**  
flue base  
construction  
fűtőcsőnk  
átmérő

 TECHNICAL

PANTECH

75 B CG L



**TÜV** 15aB-VG BImSchV2.  
CERTIFICATIONS



GARANCIA  
GUARANTEE

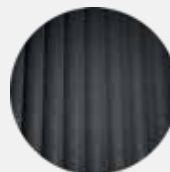

Alap kivitel fekete bélés,  
opcionális fehér bélés  
Standard black Linings,  
Option white Linings

 **200**  
flue base  
construction  
fűtőcső  
átmérő



5-9 kW



75 cm



125 kg



> 80 %



40 cm



Zárt égéstér  
Sealed Chamber  
standard



Standard



NERO  
Standard



14-16 PA



Opció  
magasító láb/  
Option  
elevating legs

 TECHNICAL

PANTECH

75 B CG R



TÜV 15aB-VG BImSchV2.  
CERTIFICATIONS



GARANCIA  
GUARANTEE



Alap kivitel fekete bélés,  
opcionális fehér bélés  
Standard black Linings,  
Option white Linings

 **200**  
flue base  
construction  
füstcsanak  
átmérő



5-9 kW



75 cm



125 kg



> 80 %



40 cm



Zárt égéstér  
Sealed Chamber  
standard



Standard



NERO  
Standard



14-16 PA



Opció  
magasító láb/  
Option  
elevating legs

**TECHNICAL**

**PANTECH**

80 B



**TÜV** 15aB-VG **BlmSchV2.**  
CERTIFICATIONS



**GARANCIA  
GUARANTEE**

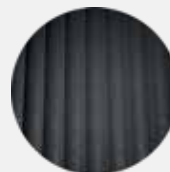

Alap kivitel fekete bélés,  
opcionális fehér bélés  
Standard black Linings,  
Option white Linings

**200**  
flue base  
construction  
fűtőcsanak  
átmérő



6-10 kW



80 cm



140 kg



> 80 %



55 cm



Zárt égéstér  
Sealed Chamber  
standard



Standard



NERO  
Standard



14-16 PA



Opció  
magasító láb/  
Option  
elevating legs

# PanTech Mobil

NEW LINE



A Pantech Mobil készülékek fejlesztésénél alapvető szempontunk volt, hogy egy könnyen telepíthető, modern letisztult vonalú készülékeket tudjunk a vásárlóink részére biztosítani. Többféle formában, színben és méretben gyártjuk már ezeket. Alapvetően a PanTech B tűztér család tagjaival készülnek. Természetesen a hosszú élettartam és kiváló hatásfok könnyű kezelhetőség itt is biztosított a zárt rendszerű tűzterekkel.

 TECHNICAL

PANTECH

60 B MOBIL BLACK / WHITE 1+2



TÜV 15aB-VG BImSchV2.  
CERTIFICATIONS



GARANCIA  
GUARANTEE

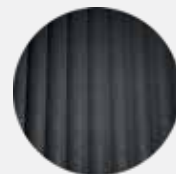

Alap kivitel fekete bélés,  
opcionális fehér bélés  
Standard black Linings,  
Option white Linings



4-6 kW



70 cm



156 kg



> 80 %



30 cm



Zárt égéstér  
Sealed  
Chamber  
standard



NERO  
Standard



**150**  
flue base  
construction  
füstcsanak  
átmérő

 TECHNICAL

PANTECH

60 B MOBIL BLACK / WHITE 2+2



TÜV 15aB-VG BImSchV2.  
CERTIFICATIONS



GARANCIA  
GUARANTEE



Alap kivitel fekete bélés,  
opcionális fehér bélés  
Standard black Linings,  
Option white Linings



4-6 kW



70 cm



171 kg



> 80 %



30 cm



Zárt égéstér  
Sealed  
Chamber  
standard



NERO  
Standard



14-16 PA



Standard



**150**  
flue base  
construction  
fűtőcsanak  
átmérő

 **TECHNICAL**

**PANTECH**

60 B CG R MOBIL BLACK / WHITE 1+2



**TÜV** 15aB-VG **BlmSchV2.**  
CERTIFICATIONS



**GARANCIA  
GUARANTEE**

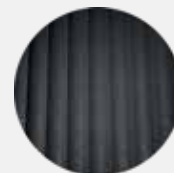

Alap kivitel fekete bélés,  
opcionális fehér bélés  
Standard black Linings,  
Option white Linings



4-6 kW



70 cm



150 kg



> 80 %



30 cm



Zárt égéstér  
Sealed  
Chamber  
standard



NERO  
Standard



**150**  
flue base  
construction  
fűtőcsanak  
átmérő



**TECHNICAL**

**PANTECH**

60 B CG R MOBIL BLACK / WHITE 2+2



**TÜV** 15aB-VG BImSchV2.  
CERTIFICATIONS



**GARANCIA  
GUARANTEE**



Alap kivitel fekete bélés,  
opcionális fehér bélés  
Standard black Linings,  
Option white Linings



4-6 kW



70 cm



159 kg



> 80 %



30 cm



Zárt égéstér  
Sealed  
Chamber  
standard



NERO  
Standard



14-16 PA



Standard



**150**  
flue base  
construction  
fűtőcsőnk  
átmérő

**TECHNICAL**

**PANTECH**

60 B CG L MOBIL BLACK / WHITE 1+2



**TÜV** 15aB-VG BImSchV2.  
CERTIFICATIONS



**GARANCIA  
GUARANTEE**

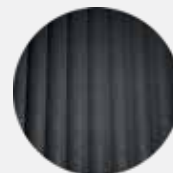

Alap kivitel fekete bélés,  
opcionális fehér bélés  
Standard black Linings,  
Option white Linings



4-6 kW



70 cm



150 kg



> 80 %



30 cm



Zárt égéstér  
Sealed  
Chamber  
standard



NERO  
Standard



**150**  
flue base  
construction  
füstcsanak  
átmérő

**TECHNICAL**

**PANTECH**

60 B CG L MOBIL BLACK / WHITE 2+2



**TÜV** 15aB-VG BImSchV2.  
CERTIFICATIONS



**GARANCIA  
GUARANTEE**



Alap kivitel fekete bélés,  
opcionális fehér bélés  
Standard black Linings,  
Option white Linings



4-6 kW



70 cm



159 kg



> 80 %



30 cm



14-16 PA



Standard



Zárt égéstér  
Sealed  
Chamber  
standard



NERO  
Standard



**150**  
flue base  
construction  
fűtőcsanak  
átmérő

 TECHNICAL

PANTECH

60 B U MOBIL BLACK / WHITE 1+2



**TÜV** 15aB-VG BlmSchV2.  
CERTIFICATIONS



GARANCIA  
GUARANTEE

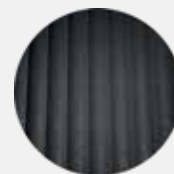

Alap kivitel fekete bélés,  
opcionális fehér bélés  
Standard black Linings,  
Option white Linings



4-6 kW



57 cm



150 kg



> 80 %



30 cm



Standard



Zárt égéstér  
Sealed  
Chamber  
standard



14-16 PA



NERO  
Standard



**150**  
flue base  
construction  
füstcsonk  
átmérő

 TECHNICAL

PANTECH

60 B U MOBIL BLACK / WHITE 2+2



TÜV 15aB-VG BImSchV2.  
CERTIFICATIONS



GARANCIA  
GUARANTEE



Alap kivitel fekete bélés,  
opcionális fehér bélés  
Standard black Linings,  
Option white Linings



4-6 kW



57 cm



159 kg



> 80 %



30 cm



Standard



Zárt égéstér  
Sealed  
Chamber  
standard



14-16 PA



NERO  
Standard



**150**  
flue base  
construction  
füstcsanak  
átmérő

 TECHNICAL

PANTECH

PANTECH 80 JOY U LD MOBIL  
BLACK / WHITE 1+2



TÜV  
CERTIFICATIONS

15aB-VG BImSchV2.



GARANCIA  
GUARANTEE

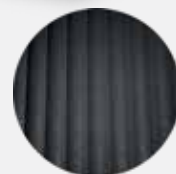

Alap kivitel fekete bélés,  
opcionális fehér bélés  
Standard black Linings,  
Option white Linings



4-6 kW



70 cm



150 kg



> 80 %



30 cm



Standard



Zárt égéstér  
Sealed  
Chamber  
standard



14-16 PA



NERO  
Standard



**150**  
flue base  
construction  
fűtőcsanak  
átmérő

 **TECHNICAL**

**PANTECH**



**TÜV**  
CERTIFICATIONS

**15aB-VG BImSchV2.**



**GARANCIA  
GUARANTEE**

PANTECH 80 JOY V LD MOBIL  
BLACK / WHITE 1+2



Alap kivitel fekete bélés,  
opcionális fehér bélés  
Standard black Linings,  
Option white Linings



4-6 kW



?? cm



159 kg



> 80 %



30 cm



Standard



Zárt égéstér  
Sealed  
Chamber  
standard



14-16 PA



NERO  
Standard



**150**  
flue base  
construction  
fűtcsanak  
átmérő







# PANTECH JOY

Tűztér család / Firebox family



## Teljesítmény és hatások:

A legújabb fejlesztésű tűztér családunk, melyet úgy terveztünk, hogy megfeleljen korunk elvárásainak, igényeinek és tökéletes élvezeti értéket nyújtson Önnek. Minden PanTech JOY készülék liftes ajtóval rendelkezik, mely egyszerű és elegáns kezelést tesz lehetővé, csökken a tűztér kifüstölési hajlama, ami rossz huzatviszonyok mellett rendkívül fontos. A modern NERO üvegezéssel éri el a lehető legnagyobb üvegfelületet. Zárt égésterű tűztér, utánégető rendszerrel, ami által szellőzőberendezésekkel egy légtérben is kiválóan működik.

## Efficiency and performance:

Our brand new line of fireplaces, designed to meet the demands of our time and to give you the perfect enjoyment. All PanTech JOY units have premium lift door system that provides easy and elegant handling and reduce the tendency of the firebox to fumigate, which could be very important in poor draft conditions. The modern NERO glazing achieves the largest possible glass surface. The sealed combustion chamber and the afterburner system secures to working perfectly even with a ventilation equipment in the same space.

# PANTECH JOY

Szerkezet / Structure



- 1 Secunder levegő, légfüggöny  
Secondary air, air curtain
- 2 Harmadlagos levegő  
Tertiary air
- 3 Szintezőláb  
Leveling feet
- 4 Légfüggöny szabályzókar  
Air curtain control lever
- 5 Égési levegő szabályzókar  
Combustion air control lever
- 6 Hőálló bélés  
Thermostable padding

**TECHNICAL**

**PANTECH**

80 JOY CG LD L



**TÜV** 15aB-VG BImSchV2.  
CERTIFICATIONS



**GARANCIA  
GUARANTEE**

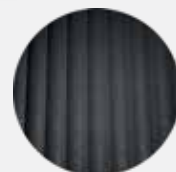

Alap kivitel fekete bélés,  
opcionális fehér bélés  
Standard black Linings,  
Option white Linings



4-7 kW



80 cm



217 kg



> 80 %



35 cm



Zárt égéstér  
Sealed  
Chamber



0,09 %



12-16 PA



NERO  
Standard



Standard



**200**

flue base  
construction  
fűstcsanak  
átmérő

**TECHNICAL**

**PANTECH**

80 JOY CG LD R



**TÜV** 15aB-VG BImSchV2.  
CERTIFICATIONS



**GARANCIA  
GUARANTEE**



Alap kivitel fekete bélés,  
opcionális fehér bélés  
Standard black Linings,  
Option white Linings



4-7 kW



80 cm



217 kg



> 80 %



35 cm



Zárt égéstér  
Sealed  
Chamber  
standard



0,09 %



12-16 PA



NERO  
Standard



Standard

**200**  
flue base  
construction  
fűtcsónk  
átmérő

 TECHNICAL

PANTECH

80 JOY U LD



**TÜV** 15aB-VG BImSchV2.  
CERTIFICATIONS



GARANCIA  
GUARANTEE

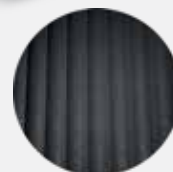

Alap kivitel fekete bélés,  
opcionális fehér bélés  
Standard black Linings,  
Option white Linings



4-7 kW



80 cm



203 kg



> 80 %



35 cm



Zárt égéstér  
Sealed  
Chamber



0,09 %



12-16 PA



NERO  
Standard



Standard



**200**  
flue base  
construction  
fűtőcsanak  
átmérő

 **TECHNICAL**

**PANTECH**

80 JOY V LD



**TÜV** 15aB-VG BImSchV2.  
CERTIFICATIONS



**GARANCIA  
GUARANTEE**

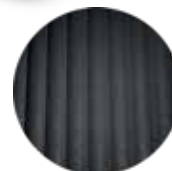

Alap kivitel fekete bélés,  
opcionális fehér bélés  
Standard black Linings,  
Option white Linings



4-7 kW



80 cm



256 kg



> 80 %



45-50 cm



Zárt égéstér  
Sealed  
Chamber



0,09 %



12-16 PA



NERO  
Standard



Standard

 **200**  
flue base  
construction  
fűtőcsanak  
átmérő

 TECHNICAL

PANTECH

PANTECH 100 JOY CG L



**TÜV** 15aB-VG BImSchV2.  
CERTIFICATIONS



GARANCIA  
GUARANTEE



Alap kivitel fekete bélés,  
opcionális fehér bélés  
Standard black Linings,  
Option white Linings



5-9 kW



80 cm



259 kg



> 80 %



60 cm



Standard



Zárt égéstér  
Sealed  
Chamber  
standard



14-16 PA



NERO  
Standard



**200**  
flue base  
construction  
fűtőcsanak  
átmérő



 TECHNICAL

PANTECH

PANTECH 100 JOY CG R



TÜV  
CERTIFICATIONS

15aB-VG BImSchV2.



GARANCIA  
GUARANTEE



Alap kivitel fekete bélés,  
opcionális fehér bélés  
Standard black Linings,  
Option white Linings



5-9 kW



80 cm



259 kg



> 80 %



60 cm



Standard



Zárt égéstér  
Sealed  
Chamber  
standard



14-16 PA



NERO  
Standard



**200**  
flue base  
construction  
fűtőcsanak  
átmérő

 TECHNICAL

PANTECH

100 JOY LD



**TÜV** 15aB-VG BImSchV2.  
CERTIFICATIONS



GARANCIA  
GUARANTEE

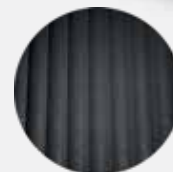

Alap kivitel fekete bélés,  
opcionális fehér bélés  
Standard black Linings,  
Option white Linings



4-7 kW



100 cm



210 kg



> 80 %



45-50 cm



Zárt égéstér  
Sealed  
Chamber  
standard



0,09 %



12-16 PA



NERO  
Standard



Standard



**200**  
flue base  
construction  
fűtőcsanak  
átméő



# PANTECH

Tűztér család / Firebox family



## Teljesítmény és hatások:

Nagy hőleadó felületek, 3-5 darab bordázott hőcsatorna, másodlagos és harmadlagos levegőellátás, teljesen zárt égéstér, alapkivitelben külső levegő ellátás és levegő előmelegítő rendszerrel.

## Élettartam:

4-5 mm-es falvastagságok, Accutech bélés, porleválasztó és lángterelő rendszer alkalmazása öntvény füstcsappantyúval. Magas szintű, hosszú fejlesztő mérnöki munka eredménye.

## Design:

Diszkrét kezelőszervek, maximális üvegfelület, NERO üvegezés. Ez a tűztér már a jövő elvárásainak megfelelő technológiai fejlesztéssel készült.

## Efficiency and performance:

Big heat dissipation surfaces, 3-5 ribbed heat channels, secondary and tertiary air supply, completely closed combustion chamber, external air supply and air preheater system.

## Lifetime:

The 4 to 5 mm thick walls, fire-brick and Accutech lining, dust separator and baffle system with molding flap are all the result of high quality and long engineering.

## Desing:

Unobtrusive handles, big glass surfaces, NERO glasses. This firebox was made by using the innovation that meets the requirements of the future.

# PANTECH EVO PREMIUM

Szerkezet / Structure



- 1 Füsttömeg szabályozás. Fontos a füsttömeg kiáramlásának torlasztása az égésidő és a hatásfok növelésének érdekében.  
Regulation of the smoke crowd. To reach the improving burning time and the efficiency with the help of the blocking of the exhaust of the smoke is important
- 2 Hócsatorna  
Heating channel
- 3 Secunder levegő, légfüggöny  
Secondary air, air curtain
- 4 Utánégető  
Afterburner
- 5 Rostély  
Grate
- 6 Hamuláda  
Ash box
- 7 Hóálló bélés  
Thermostable padding
- 8 Szintezőláb  
Leveling foot
- 9 Levegő szabályzókar  
Air controlling lever

**TECHNICAL**

**PANTECH**

68 EVO



**TÜV** 15aB-VG **BlmSchV2.**  
CERTIFICATIONS



**GARANCIA  
GUARANTEE**

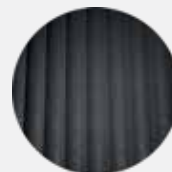

Alap kivitel fekete bélés,  
opcionális fehér bélés  
Standard black Linings,  
Option white Linings



Opció  
magasító láb/  
Option  
elevating legs



7-13 kW



68 cm



179 kg



> 80 %



> 84 %



40 cm



Zárt égéstér  
Sealed  
Chamber



Standard



0,09 %



12-16 PA



25  
mg/Nm<sup>3</sup>



NERO  
Standard

~~200~~  
flue base  
construction  
fűtcsonk  
átmérő

~~150~~  
flue can be  
ordered  
választható  
fűtcsonk  
átmérő

**PANTECH**  
68 EVO TUNNEL

**5** GARANCIA  
GUARANTEE

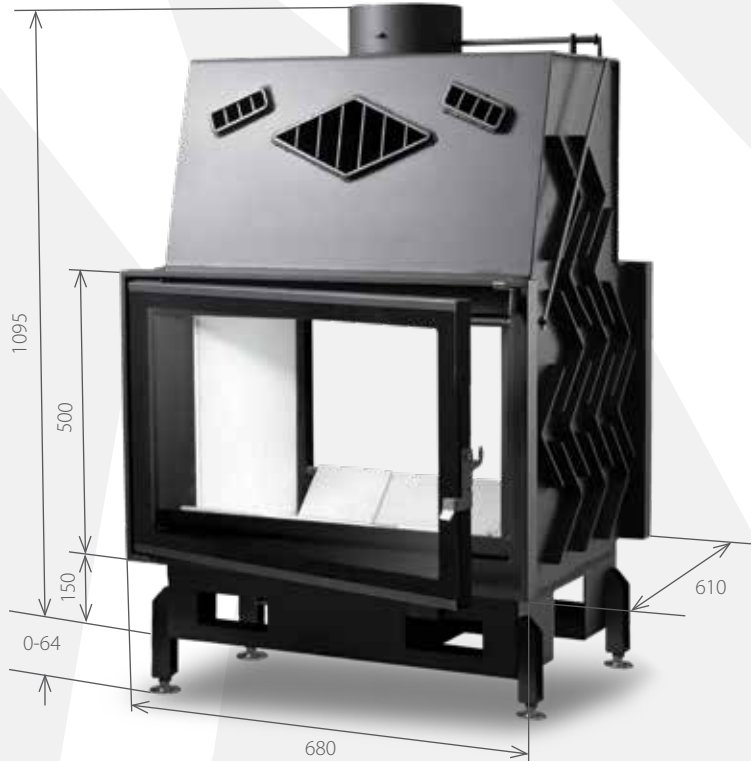

Alap kivitel fekete bélés,  
opcionális fehér bélés  
Standard black Linings,  
Option white Linings



Opció  
magasító láb/  
Option  
elevating legs



7-13 kW



68 cm



204 kg



> 80 %



> 84 %



40 cm



Zárt égéster  
Sealed  
Chamber



Standard



0,09 %



12-16 PA



25  
mg/Nm<sup>3</sup>



NERO  
Standard

**200**  
flue base  
construction  
fűtőcsanak  
átmérő

**TECHNICAL**

**PANTECH**

80 EVO



**TÜV** 15aB-VG BImSchV2.  
CERTIFICATIONS

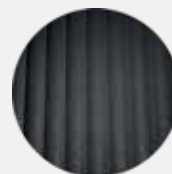

Alap kivitel fekete bélés,  
opcionális fehér bélés  
Standard black Linings,  
Option white Linings



Opció  
magasító láb/  
Option  
elevating legs



14 kW



80 cm



204 kg



> 80 %



> 84 %



55 cm



Zárt égéstér  
Sealed  
Chamber



Standard



0,09 %



12-16 PA



25  
mg/Nm<sup>3</sup>



NERO  
Standard

**200**  
flue base  
construction  
fűtőcsanak  
átmérő



# PANTECH

## 80 EVO TUNNEL

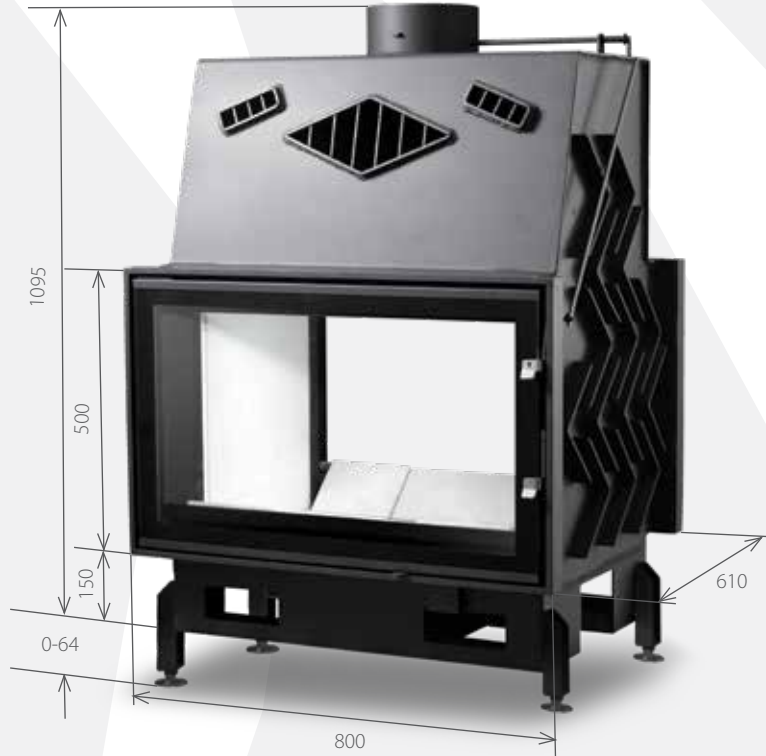

Alap kivitel fekete bélés,  
opcionális fehér bélés  
Standard black Linings,  
Option white Linings



Opció  
magasító láb/  
Option  
elevating legs



10-17 kW



80 cm



230 kg



> 80 %



> 84 %



55 cm



Zárt égéstér  
Sealed  
Chamber



Standard



0,09 %



12-16 PA



25  
mg/Nm<sup>3</sup>



NERO  
Standard

 **200**  
flue base  
construction  
füstcsanak  
átmérő

 **TECHNICAL**

**PANTECH**

80 EVO LD



**TÜV** 15aB-VG **BlmSchV2.**  
CERTIFICATIONS



**GARANCIA  
GUARANTEE**



13 kW



80 cm



230 kg



> 80 %



> 84 %



40 cm



Zárt égéstér  
Sealed  
Chamber



Standard



0,09 %



12-16 PA



25  
mg/Nm<sup>3</sup>



NERO  
Standard



Opció  
magasító láb/  
Option  
elevating legs

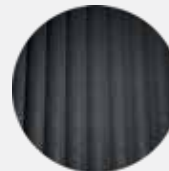

Alap kivitel fekete bélés,  
opcionális fehér bélés  
Standard black Linings,  
Option white Linings



**200**  
flue base  
construction  
füstcsanak  
átmérő



**GARANCIA  
GUARANTEE**

# PANTECH

## 80 EVO LD TUNNEL



TUNNEL/2 ajtós kivitel



Opció  
magasító láb/  
Option  
elevating legs

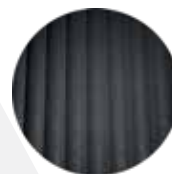

Alap kivitel fekete bélés,  
opcionális fehér bélés  
Standard black Linings,  
Option white Linings



6-12 kW



80cm



310 kg



> 80 %



> 84 %



40 cm



Zárt égéster  
Sealed  
Chamber



Standard



0,1 %



12-16 PA



25  
mg/Nm<sup>3</sup>



NERO  
Standard



**200**  
flue base  
construction  
fűtőcsanak  
átmérő

**TECHNICAL**

**PANTECH**

90 EVO CG LD L



**TÜV** 15aB-VG **BlmSchV2.**  
CERTIFICATIONS



**GARANCIA  
GUARANTEE**



Opció  
magasító láb/  
Option  
elevating legs

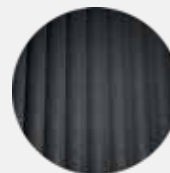

Alap kivitel fekete bélés,  
opcionális fehér bélés  
Standard black Linings,  
Option white Linings



8-14 kW



89 cm



280 kg



> 80 %



> 84 %



55 cm



Zárt égéstér  
Sealed  
Chamber



Standard



0,09 %



12-16 PA



25  
mg/Nm<sup>3</sup>



NERO  
Standard



**200**  
flue base  
construction  
fűtőcsanak  
átmérő

**TECHNICAL**

**PANTECH**

90 EVO CG LD R



**TÜV** 15aB-VG **BlmSchV2.**  
CERTIFICATIONS



**GARANCIA  
GUARANTEE**



Opció  
magasító láb/  
Option  
elevating legs



Alap kivitel fekete bélés,  
opcionális fehér bélés  
Standard black Linings,  
Option white Linings



8-14 kW



89 cm



280 kg



> 80 %



> 84 %



55 cm



Zárt égéstér  
Sealed  
Chamber



Standard



0,09 %



12-16 PA



25  
mg/Nm<sup>3</sup>



NERO  
Standard



**200**  
flue base  
construction  
füstcsonk  
átmérő

 TECHNICAL

PANTECH

100 EVO LD



TÜV 15aB-VG BImSchV2.  
CERTIFICATIONS



GARANCIA  
GUARANTEE



Opció  
magasító láb/  
Option  
elevating legs

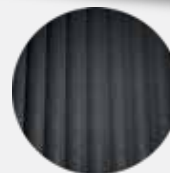

Alap kivitel fekete bélés,  
opcionális fehér bélés  
Standard black Linings,  
Option white Linings



14 kW



96 cm



260 kg



> 80 %



> 84 %



55 cm



Zárt égéstér  
Sealed  
Chamber



Standard



0,09 %



12-16 PA



25  
mg/Nm<sup>3</sup>



NERO  
Standard



**200**  
flue base  
construction  
fűtőcsanak  
átmérő



TUNNEL/2 ajtós kivitel



Opció  
magasító láb/  
Option  
elevating legs



Alap kivitel fekete bélés,  
opcionális fehér bélés  
Standard black Linings,  
Option white Linings



8-14 kW



93 cm



356 kg



> 80 %



> 84 %



55 cm



Zárt égéstér  
Sealed  
Chamber



Standard



0,1 %



12-16 PA



25  
mg/Nm<sup>3</sup>



NERO  
Standard

**200**  
flue base  
construction  
füstcsanak  
átmérő

**TECHNICAL**

**PANTECH**

100 EVO U LD



**TÜV** 15aB-VG BImSchV2.  
CERTIFICATIONS



**GARANCIA  
GUARANTEE**



Opció  
magasító láb/  
Option  
elevating legs

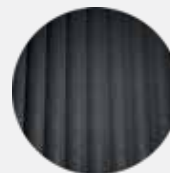

Alap kivitel fekete bélés,  
opcionális fehér bélés  
Standard black Linings,  
Option white Linings



8-14 kW



99 cm



302 kg



> 80 %



> 84 %



55 cm



Zárt égéstér  
Sealed  
Chamber



Standard



0,1 %



12-16 PA



25  
mg/Nm<sup>3</sup>



NERO  
Standard



**200**  
flue base  
construction  
füstcsanak  
átmérő



**TECHNICAL**

**PANTECH**

100 EVO V LD



**TÜV** 15aB-VG BImSchV2.  
CERTIFICATIONS



**GARANCIA  
GUARANTEE**



Opció  
magasító láb/  
Option  
elevating legs

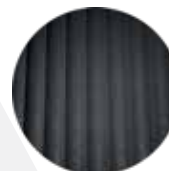

Alap kivitel fekete bélés,  
opcionális fehér bélés  
Standard black Linings,  
Option white Linings



8-14 kW



90 cm



389 kg



> 80 %



> 84 %



55 cm



Zárt égéstér  
Sealed  
Chamber



Standard



0,1 %



12-16 PA



25  
mg/Nm<sup>3</sup>



NERO  
Standard



**200**  
flue base  
construction  
fűtőcsanak  
átmérő

 TECHNICAL

PANTECH

110 EVO



TÜV 15aB-VG BImSchV2.  
CERTIFICATIONS



GARANCIA  
GUARANTEE

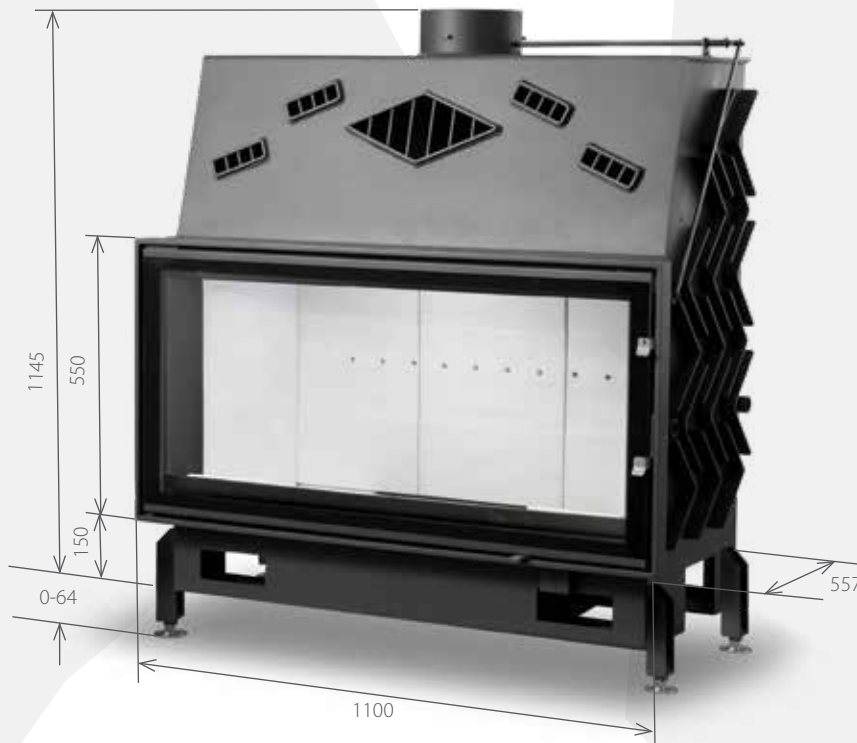

Opció  
magasító láb/  
Option  
elevating legs

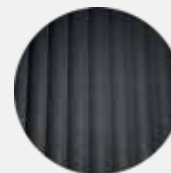

Alap kivitel fekete bélés,  
opcionális fehér bélés  
Standard black Linings,  
Option white Linings



12-21 kW



110 cm



288 kg



> 80 %



> 84 %



70 cm



Zárt égéstér  
Sealed  
Chamber



Standard



0,09 %



12-16 PA



25  
mg/Nm<sup>3</sup>



NERO  
Standard



**200**  
flue base  
construction  
fűtőcsanak  
átmérő

 TECHNICAL

PANTECH

110 EVO TUNNEL



TÜV 15aB-VG BImSchV2.  
CERTIFICATIONS



GARANCIA  
GUARANTEE



Opció  
magasító láb/  
Option  
elevating legs



Alap kivitel fekete bélés,  
opcionális fehér bélés  
Standard black Linings,  
Option white Linings



12-21 kW



110 cm



313 kg



> 80 %



> 84 %



70 cm



Zárt égéstér  
Sealed  
Chamber



Standard



0,09 %



12-16 PA



25  
mg/Nm<sup>3</sup>



NERO  
Standard



**200**  
flue base  
construction  
füstcsonk  
átmérő

 **TECHNICAL**

**PANTECH**

130 EVO LD



**TÜV** 15aB-VG BImSchV2.  
CERTIFICATIONS



Alap kivitel fekete bélés,  
opcionális fehér bélés  
Standard black Linings,  
Option white Linings



Opció  
magasító láb/  
Option  
elevating legs



12-21 kW



126 cm



335 kg



> 80 %



> 84 %



70 cm



Zárt égéstér  
Sealed  
Chamber



Standard



0,09 %



12-16 PA



25  
mg/Nm<sup>3</sup>



NERO  
Standard

 **200**  
flue base  
construction  
fűtőcsanak  
átmérő

**TECHNICAL**

**PANTECH**

130 EVO LD TUNNEL



**TÜV** 15aB-VG BImSchV2.  
CERTIFICATIONS



**GARANCIA  
GUARANTEE**



TUNNEL / 2 ajtós kivitel

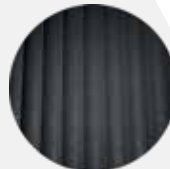

Alap kivitel fekete bélés,  
opcionális fehér bélés  
Standard black Linings,  
Option white Linings



Opció  
magasító láb/  
Option  
elevating legs



8-14 kW



126 cm



479 kg



> 80 %



> 84 %



70 cm



Zárt égéstér  
Sealed  
Chamber



Standard



0,1 %



12-16 PA



25  
mg/Nm<sup>3</sup>



NERO  
Standard

**200**  
flue base  
construction  
fűtcsonk  
átmérő

**TECHNICAL**

**PANTECH**

160 EVO LD



**TÜV** 15aB-VG **BlmSchV2.**  
CERTIFICATIONS



**GARANCIA  
GUARANTEE**

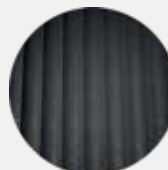

Alap kivitel fekete bélés,  
opcionális fehér bélés  
Standard black Linings,  
Option white Linings



Opció  
magasító láb/  
Option  
elevating legs



12-21 kW



153 cm



437 kg



> 80 %



> 84 %



70 cm



Zárt égéstér  
Sealed  
Chamber



Standard



0,09 %



12-16 PA



25  
mg/Nm<sup>3</sup>



NERO  
Standard



**250**  
flue base  
construction  
fűtőcsanak  
átmérő

 **TECHNICAL**

**PANTECH**

200 EVO LD



**TÜV** 15aB-VG **BlmSchV2.**  
CERTIFICATIONS



**GARANCIA  
GUARANTEE**



Alap kivitel fekete bélés,  
opcionális fehér bélés  
Standard black Linings,  
Option white Linings



Opció  
magasító láb/  
Option  
elevating legs



12-21 kW



193 cm



560 kg



> 80 %



> 84 %



70 cm



Zárt égéstér  
Sealed  
Chamber



Standard



0,09 %



12-16 PA



25  
mg/Nm<sup>3</sup>



NERO  
Standard



**300**  
flue base  
construction  
fűtőcsanak  
átmérő

# PANTECH

## CLASSIC 95



9-15 kW



95 cm



120 kg



73 %



78 %



55 cm



Option



Lábazat  
/ Legs  
Option



14-16 PA

 **200**  
flue base  
construction  
fűtcsonk  
átmérő

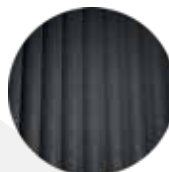

Alap kivitel fekete bélés, opcionális fehér bélés  
Standard black Linings, Option white Linings



# PANTECH

## CLASSIC 110



11-19 kW



110 cm



140 kg



73 %



78 %



70 cm



Option



Lábazat  
/ Legs  
Option



14-16 PA



**200**  
flue base  
construction  
füstcsónk  
átmérő

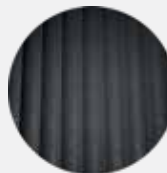

Alap kivitel fekete bélés, opcionális fehér bélés  
Standard black Linings, Option white Linings

# PANBOX

68



**GARANCIA  
GUARANTEE**

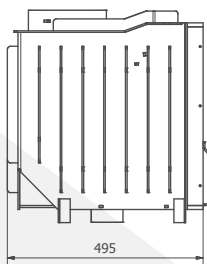
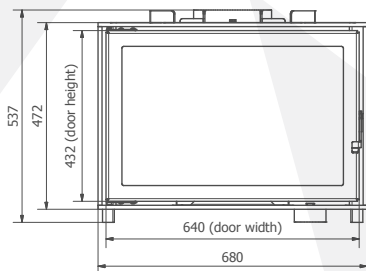
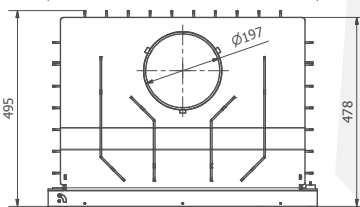
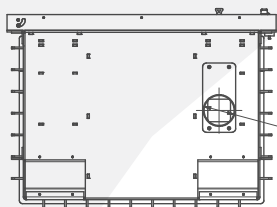

4-7 kW



104 kg



Standard



> 76 %



40 cm



14-16 PA

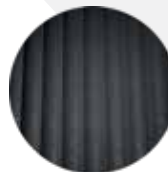

**200**  
flue base  
construction  
fűtcsonk  
átmérő

Alap kivitel fekete bélés,  
opcionális fehér bélés  
Standard black Linings,  
Option white Linings

# PANBOX

110

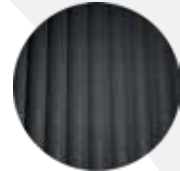

Alap kivitel fekete bélés,  
opcionális fehér bélés  
Standard black Linings,  
Option white Linings

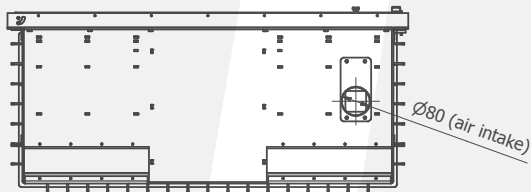

4-8 kW



173 kg



Standard



> 76 %



70 cm



14-16 PA

**200**  
flue base  
construction  
füstcsanak  
átmérő

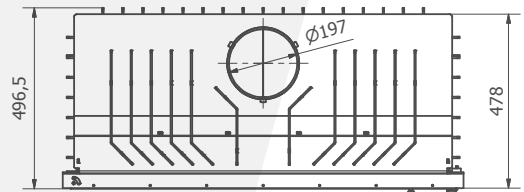
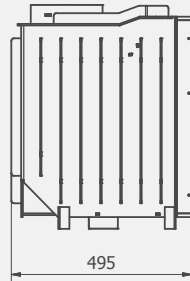
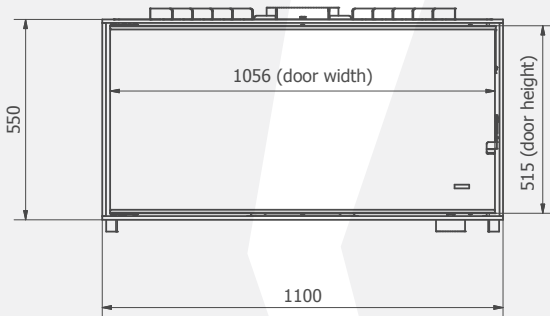

# HŐDOBOK

Heat reclaimers



A lemezhasas és az öntöttvas légfűtő tűzterek kiegészítő eleme. Alkalmazásával megnöveljük a hőleadó felületet és alacsonyabb hőmérsékleten tudjuk a füstgázt a kéménybe kibocsátani, ezzel hatásfok- és teljesítménynövelést érünk el. A hődob különlegessége az emelkedéssel elhelyezett hőleadó cső, melyek a fokozott konvekciós légáramlás növekedését segítik elő.

It is the supplementary element of disk-based and cast-iron fireboxes. It raises the heat dissipation surfaces and emits the exhaust fumes to the chimney at a lower temperature, with a help of this, higher efficiency and performance can be reached. The specialty of the heat reclaimer is the tube that assures increased convection to your living space.

# HŐDOB / HEAT RECLAIMER

150



3-4,5 kW



16 Kg

# HŐDOB / HEAT RECLAIMER

200



4-6 kW



23 Kg

# VIZES HŐDOB / WATER HEAT RECLAIMER

MINI, MAXI

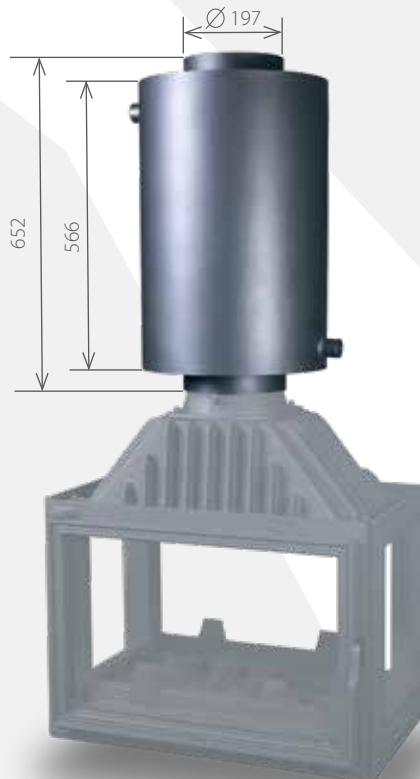
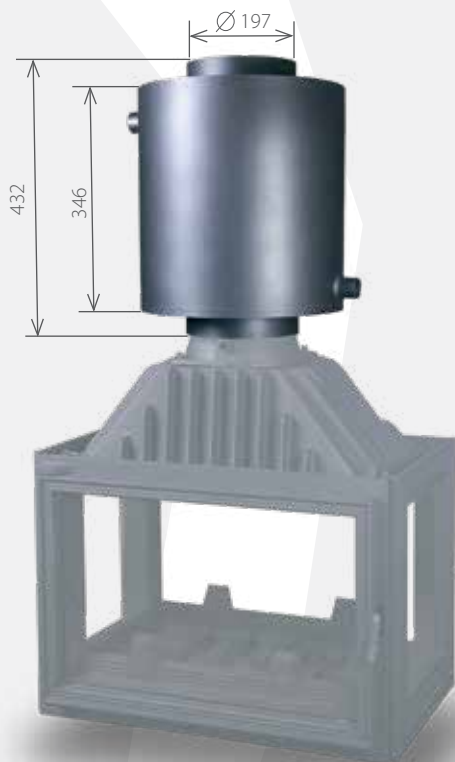

4-5 KW



13,5 L



27 Kg



7-10 KW



23,5 L



41 Kg

Csak nyitott fűtési rendszerekhez! Only for open heating systems!

# KIEGÉSZÍTŐK

## SZELLŐZŐRÁCSOK / ACCESSORIES



Vörösréz  
kandalló  
szellőzőrács  
17x17  
Zsalus: 17x17



Vörösréz , zsalus  
kandalló  
szellőzőrács  
17x17



Fehér  
kandalló  
szellőzőrács  
17x17



Fehér, zsalus  
kandalló  
szellőzőrács  
Zsalus: 17x17



Krém  
kandalló  
szellőzőrács  
17x17



Krém, zsalus  
kandalló  
szellőzőrács  
Zsalus: 17x17



# KIEGÉSZÍTŐK

## SZELLŐZŐRÁCSOK / ACCESSORIES



Króm  
kandalló  
szellőzőrács  
17x17



Rusztikus  
kandalló  
szellőzőrács  
17x17

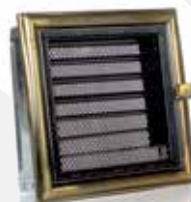

Rusztikus, zsalus  
kandalló  
szellőzőrács  
Zsalus: 17x17



Antracit  
kandalló  
szellőzőrács  
17x17



Antracit, zsalus  
kandalló  
szellőzőrács  
Zsalus: 17x17

# KIEGÉSZÍTŐK

## SZELLŐZŐRÁCSOK / ACCESSORIES



Vörösréz kandalló  
szellőzőrács  
17x30



Vörösréz zsalus  
kandalló szellőzőrács  
Zsalus: 17x30



Króm kandalló  
szellőzőrács  
17x30



Acél kandalló  
szellőzőrács  
Zsalus: 17x30



Acél zsalus  
kandalló szellőzőrács  
Zsalus: 17x30



Króm zsalus  
kandalló szellőzőrács  
17x30



Rusztikus zsalus  
kandalló szellőzőrács  
Zsalus: 17x30



Antracit kandalló  
szellőzőrács  
17x30



Antracit zsalus  
kandalló  
szellőzőrács

17x30



Krém kandalló  
szellőzőrács  
17x30



Krém kandalló  
szellőzőrács  
17x49



Fehér kandalló  
szellőzőrács  
17x49

# KIEGÉSZÍTŐK

## SZELLŐZŐRÁCSOK / ACCESSORIES



Regia 2  
kandalló szellőzőrács



Regia 5  
kandalló szellőzőrács



Króm kandalló  
szellőzőrács  
17x49



Vörösréz kandalló  
szellőzőrács  
17x49



Rusztikus kandalló  
szellőzőrács  
17x49



Antracit kandalló  
szellőzőrács  
17x49



Tunnel antracit, fehér  
szellőzőrács  
40x9cm, 56x9cm,  
80x9cm 100x9cm



Corner antracit, fehér  
szellőzőrács  
60x40x9cm, 80x40x9cm

## KIEGÉSZÍTŐK

### HŐTÁROLÓ GYŰRŰK (fél) / HEAT STORAGE RING (half)



A hőtároló rendszerek képesek felvenni kapacitásuktól függően a több órás tüzelés hőfeleslegét, ami a fa leégése után több órán keresztül temperálja a fűtendő légteret. Ezáltal egy elnyújtottabb, kellemesebb fűtést kapunk, így a kandallónk nagyon jól ötvözi egy cserépkályha és egy kandalló előnyeit.

Depending on their capacity, the heat storage systems are able to absorb the excess heat of several hours of burning, which tempers the air space to be heated for several hours after the wood burns down. As a result, we get a longer, more pleasant heating, so our fireplace combines the advantages of a tile stove and a fireplace very well.





## Bemutatótermeink / Showrooms

1103 Budapest X. Kőér u. /str. 16.  
Tel. / Phone: +36 (1) 260 2290, 06 (20) 224 7504  
2225 Üllő Hatháza u. 14.  
Mobil / Phone: +36 (20) 341 1217

Forgalmazó / Distributor

A gyártó a mindenkori változtatás jogot fenntartja.

[WWW.KANDALLOS.HU](http://WWW.KANDALLOS.HU)

© Technical tüzeléstechnika